

## TOWSON BRIDGE FAUCET / 12" ARTICULATED SPOUT / 2PC. SUITE

# 6100-12-2

- MAX COUNTER THICKNESS 2-3/8"
- MINIMUM INSTALL HOLE SIZE 1-3/8"

- A. Supply Hoses - 20" Long with 3/8" Compression Fittings
- B. Side Spray Connection with 1/4" NPT Pipe Fitting

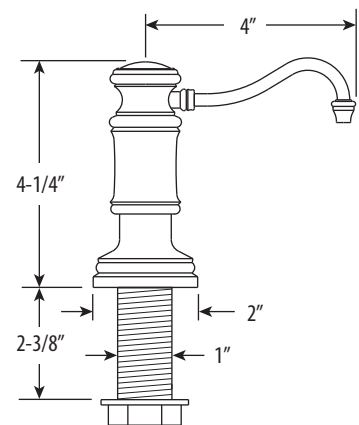
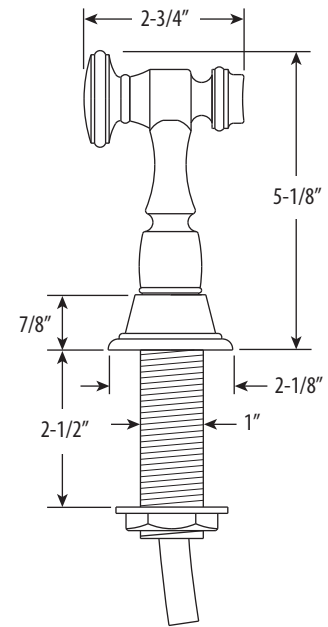
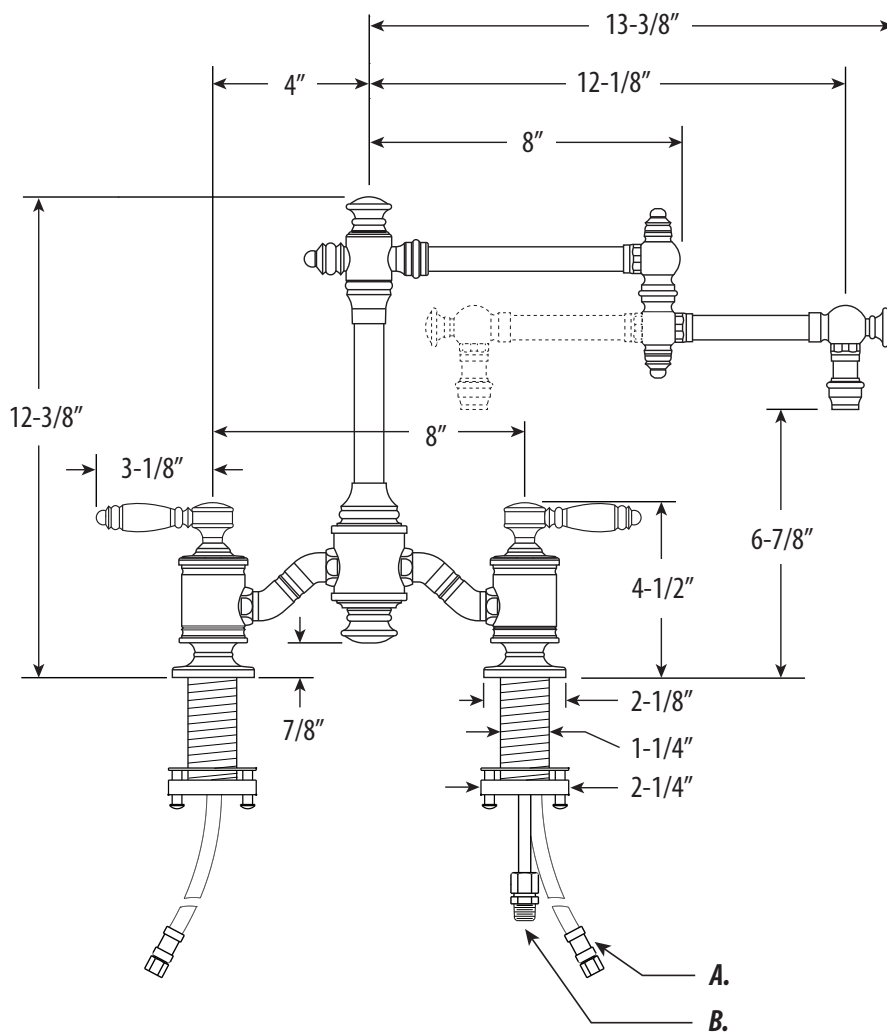

DIMENSIONS MAY VARY AND ARE SUBJECT TO CHANGE. NO RESPONSIBILITY IS ASSUMED FOR USE OF SUPERCEDED OR VOIDED DATA

