

23-1.2M-L9

Wall Mounted 2 Hole Lavatory Set

Flow Rate: 1.2 GPM

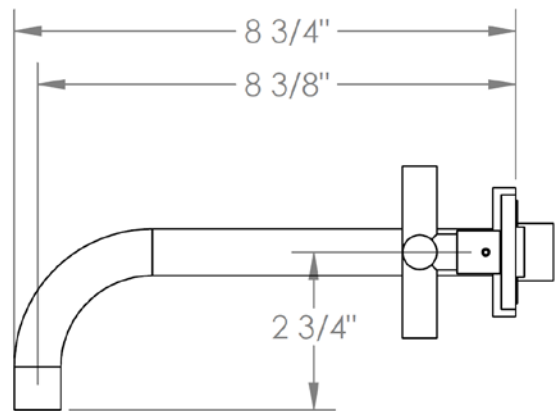
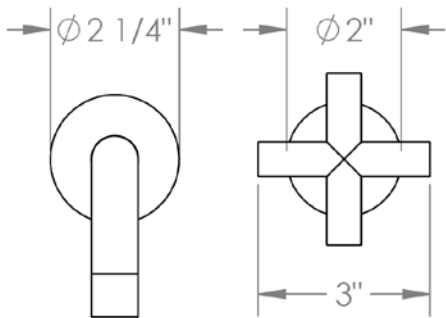

Meets the applicable requirements of ASME A112.18.1-2005/CSA B125.1-05, entitled "Plumbing Supply Fittings"