

SAMUEL HEATH

Product Number: V2K4AGC9

Description: Exposed 1/2" thermostatic shower set - bath spout and diverter



Finishes Available



Chrome Plate



Polished Nickel



Non Lacquered Brass



Antique Gold



City Bronze



Country Bronze



Brushed Gold Gloss



Brushed Gold Matt



Brushed Gold Unlacquered

Specification Drawing

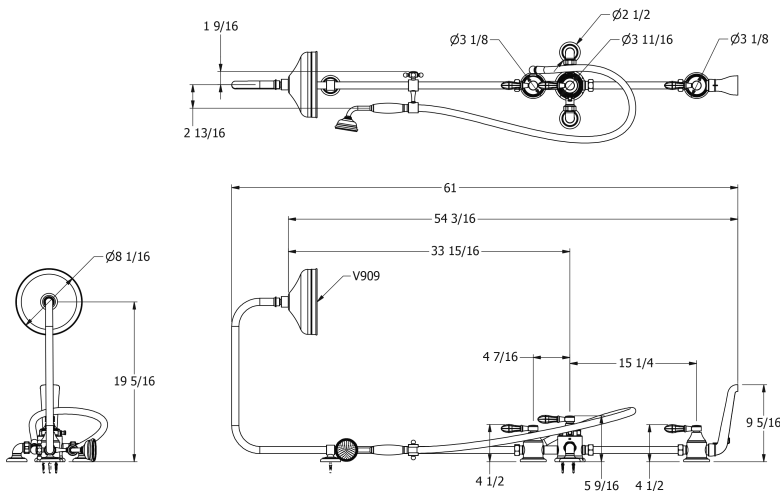

Kit Components



V221-TGC



V223



V228-TGCA



V254-AM



V271



V278-TGC



V909-A



V941



V240-A

UK Customer Service

Leopold Street
Birmingham
B12 0UJ
Tel: +44 121 766 4200
Email: info@samuel-heath.com

US Customer Service

Federal I.D. No. 58-1504682
Email: usa@samuel-heath.com

Specification Enquiries

Design Centre Chelsea Harbour
1st Floor, North Dome, London
SW10 0XE
Tel: 020 7352 0249
Email: showroom@samuel-heath.com